

CS/AP PANELS

Specifications and Color Options

Superior materials make the difference...

Premium finishes and design give Chief's Standard Panels (CS) and Chief's Architectural Panels (AP) the edge when it comes to quality steel roof and wall panels. They're ideal for a variety of other applications as well. Interior liners, fascias, canopies, and soffits are just some of the many uses for this versatile panel. With a 1 1/8" deep corrugation for added strength, 36" panel widths for quicker erection and availability in many different colors, Chief's CS and AP ribbed panels are the perfect choice for your construction project.

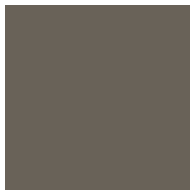

Antique Bronze (AQ)



Ash Gray (AG)



Charcoal Gray (CG)



Cherokee (CK)



Emerald Green (EG)



Fieldstone (FS)

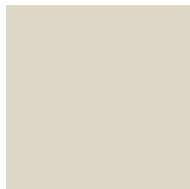

Parchment (PA)

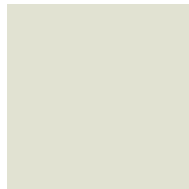

Polar White (PW)



Royale Blue (RB)



Sierra Madre (SM)

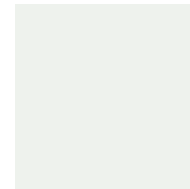

White Polyester (WP)

White Polyester

Chief's White Polyester is an economical finish intended for interior applications only and is a non-warranty product. Available in 29 ga. only.

Ultra-Kote Premium (UKP) Finish

Chief's Ultra-Kote Premium finish is made with polyvinylidene fluoride resin, where a minimum of 70% of the resin is PVDF (Kynar 500® or Hylar 5000®). This unique chemistry is combined with acrylic resin, as well as ceramic and select inorganic pigmentation. The result is Ultra-Kote Premium's proven ability to resist ultraviolet radiation in sunlight for maximum protection against general weathering effects, chalking and fading. Choose from the full selection of colors above.

*All colors 26 & 24 ga. except White Polyester (29 ga.)

**Chief maintains stock inventory of Polar White and Galvalume®. All other colors shown are available as Chief standard colors but my not be in stock.

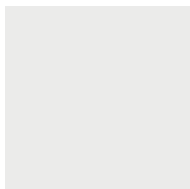

Frost White (FW)

Ultra-Kote (UK) Finish

Chief's Ultra-Kote finish is made with CERAM-A-STAR®, which sets the standard in the metal bulking industry for silicone polyester coatings. This tried-and-true coating allows metal buildings to maintain color and integrity over decades of harsh weather conditions. Its unique chemistry provides superior color stability, chalk resistance, fade resistance, and gloss retention.

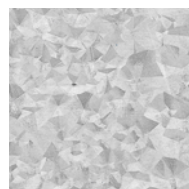

Galvalume (GM)

Acrylic Coated Galvalume® (GM)

Chief's exterior roof, wall and trim material is available in an industry standard ASTM A792 Acrylic Coated Galvalume® finish. Galvalume® is a unique coating of 55% aluminum and 45% zinc that resists corrosion. The Galvalume® sheet is coated with a thin, clear acrylic coating applied to both sides.

Since all color chips are affected by age, lighting conditions, heat and mechanical coating processes, the chips on this page may vary slightly in color or finish from the actual product. Oil canning in the flat areas of panels is inherent of coil steel products and shall not be a cause for product refusal. Chief reserves the right to change designs, prices and specifications at any time without notice.



Chief's Finish Warranties:

Ultra-Kote Premium Panel Finish Limited Warranty - 35 year | Ultra-Kote Panel Finish Limited Warranty - 25 year | Galvalume® Panel Limited Warranty - 25 year



1821 S. North Road / PO Box 2078 / Grand Island, NE 68802-2078 / (308) 389-7281 / www.chiefbuildings.com

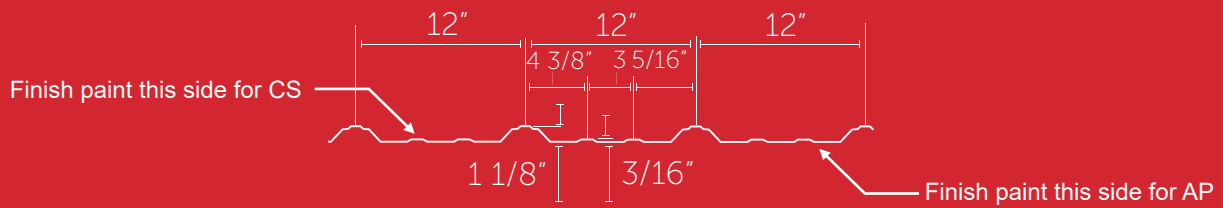

Note: Dimensions are nominal.

Ribbed Roof Panel

- Roll-formed profile shall be CS (Chief Standard) configuration as manufactured by Chief Buildings. Panels shall have 1 1/8" deep major ribs spaced at 12" on center, with minor ribs between major ribs. Each panel shall provide a net coverage width of 36".
- Panels shall be manufactured from 26 gauge or 24 gauge, 80,000 PSI material.
- Provide roof panel assemblies with permanent resistance to air leakage through assembly of not more than 0.005 cfm/sf of fixed roof area when tested according to ASTM E1680 at a static pressure differential of 6.24 psf.
- Provide roof panel assemblies with no water penetration as defined in the test method when tested according to ASTM E1646 at a static pressure differential of 12.0 psf.
- Provide roof panel assemblies with UL Class 30, 60, or 90 uplift rating in accordance with UL 580 "Tests for Uplift Resistance of Roof Assemblies".
- Provide roof panel assemblies with UL Class A Fire Rating in accordance with UL 790 "Test Methods for Fire Tests of Roof Coverings".
- Provide roof panel assemblies with UL Class 4 Impact Rating in accordance with UL 2218 "Impact Resistance of Prepared Roof Covering Material".
- Panels shall be one piece for slope lengths less than 39'-6". Endlaps, if required, shall be 8" and occur at a purlin.
- Panel finish shall be acrylic coated Galvalume® AZ55 coating in accordance with ASTM A792.

OR

Substrate shall be Galvalume® AZ50 coating in accordance with ASTM A792. Sheets shall be coated with a fluoropolymer topcoat containing not less than 70% polyvinylidene fluoride (PVDF) over primer with total DFT of 0.8-1.0. The reverse side shall be coated with pigmented polyester. Exterior color to be selected from Chief standard color choices.

Exterior Wall Panel

- Roll-formed profile shall be CS (Chief Standard) or AP (Architectural Panel) configuration as manufactured by Chief Buildings. Panels shall have 1 1/8" deep major ribs spaced at 12" on center, with minor ribs between major ribs. Each panel shall provide a net coverage width of 36".
- Manufactured from 26 gauge or 24 gauge, 50,000 PSI or 80,000 PSI material.
- Provide wall panel assemblies (when installed with mastic in the walls) with permanent resistance to air leakage through assembly of not more than 0.006 cfm/sf of fixed wall area when tested according to ASTM E283 at a static pressure differential of 6.24 psf.
- Provide wall panel assemblies (when installed with mastic in the walls) with no water penetration as defined in the test method when tested according to ASTM E331 at a static pressure differential of 12.0 psf.
- Substrate shall be Galvalume® AZ50 coating in accordance with ASTM A792.
- Sheets shall be coated with a fluoropolymer topcoat containing not less than 70% polyvinylidene fluoride (PVDF) over primer with total DFT of 0.8-1.0. The reverse side shall be coated with pigmented polyester. Exterior color to be selected from Chief standard color choices.

Eave Trim

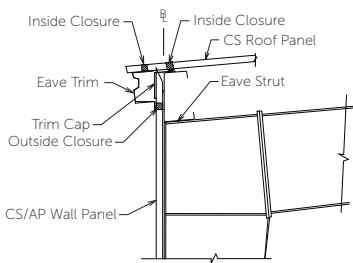

Eave Gutter

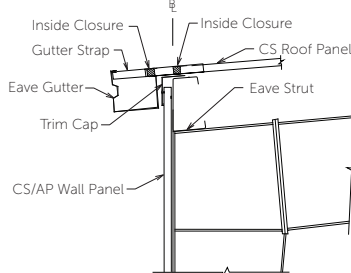

Gable Trim

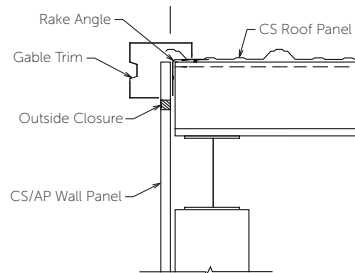

Outside Corner

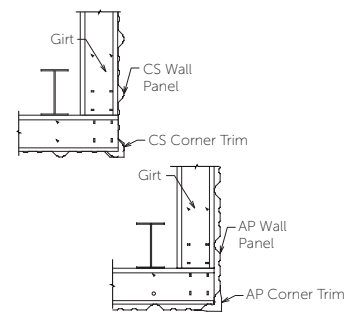

Notch in Concrete

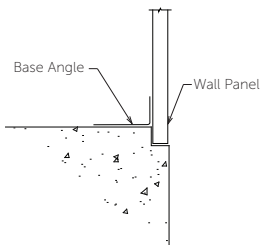

Base Trim with Drip Edge

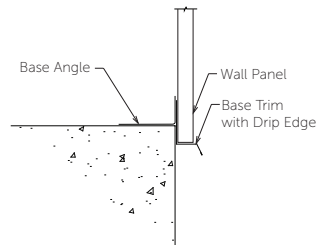

Base Trim with Return Leg

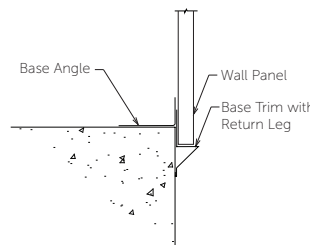

One Piece Base Member

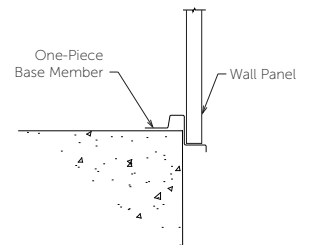

Galvalume® is a registered trademark of BIEC International, Inc. | Kynar 500® is a registered trademark of Arkema, Inc. | Hylar 5000® is a registered trademark of Solvay Solexis, Inc. CERAM-A-STAR® is a registered trademark of AkzoNobel



1821 S. North Road / PO Box 2078 / Grand Island, NE 68802-2078 / (308) 389-7281 / www.chiefbuildings.com